

## Computer simulation of aggregation phenomena based on co-operative linking mechanism in polymers

L. Carpaneto\* and E. Marsano

Instituto di Chimica Industriale, Università di Genova, C.so Europa 30, I-16132 Genova, Italy

### Summary

The development of a model polymeric system where chains can interact and form aggregates of different size and shape by a cooperative linking mechanism is here reported. With a description of the algorithm determining the dynamics of the chains and the formation of stable linkages between them, we report the first results in function of volume concentration and molecular length. A comparison with experimental systems is also proposed with a tentative interpretation of the phase behaviors of different polysaccharides of qualitative nature.

### Introduction

It is well known that polymers such as polysaccharides show the possibility to give aggregates thanks to weak or relatively weak non-covalent forces such as hydrogen bonds, hydrophobic interactions and so on (1,2). The formation of aggregates, gels or precipitates in solutions of these polymers can be ascribed to these forces, but the dependence on the molecular weight and concentration of their phase behavior is not easily interpreted. It has been proposed that these systems could form stable bonds thanks to weak interactions acting along extended chain segments in a sort of co-operative mechanism (1,2). In fact, the phase diagrams of some polysaccharides and some peculiar differences in their behaviors could be explained in function of such a mechanism and of the ratio between the length of the molecules and the extension of the sequences that must be involved in forming stable linkages with other chains (1); of course the peculiar chemical nature of different polysaccharides should justify their different phase diagrams even in presence of the same linking mechanism. At this regard we can compare two chemical systems such as cellulose and chitin and observe their different possibility to give a liquid crystalline phase. A critical parameter to evaluate the mesogenic nature of a polymer is its rigidity, expressed by the ratio between its Kuhn segment and the chain diameter, a value called axial ratio; high values of this ratio, in general, allow macromolecular systems to stabilize a liquid crystalline phase (3). But whereas, for example, cellulose can give this kind of phase in solution (4), chitin, that is much more rigid, never shows such a property, independently of the molecular weight and concentration of the samples (5). Therefore it can be supposed that aggregation phenomena, occurring in this polymer even at low concentration, can affect the value of its axial ratio, in a way we will discuss later.

### The model

The model used in this work, developed on the base of others used to study aggregation phenomena (6), simulates the movement of the chains according to a specific algorithm and assumes that stable interactions between two or more chains can be attained thanks to the cooperation of weak bonds along extended chain segments. Polymer chains are here represented as strings of connected beads, placed in a cubic lattice, that obey excluded volume rules, i.e. each lattice site can be occupied by no more than one chain segment at the same time. The random walk of the polymers is rendered by the Verdier-Stockmayer algorithm (6) which, in principle, simulates the shifting and wiggling motion derived from the collisions of the chains with solvent molecules. In this algorithm the end beads can move more freely than the others constituting the chain, having the possibility to explore five different

\*Corresponding author

lattice sites, while the beads located at an angle of the model chain can only shift to the cell on the opposite vertex of a hypothetical square; beads that are collinear with their two adjacent neighbors cannot undergo any kind of movement in the lattice. The way this algorithm operates is schematically reported in figure 1. In this paper we report specifically the behavior of model chains composed by ten, twenty, thirty and forty beads. The first step in the simulation has been the relaxation of the single extended chains, according to the above mentioned algorithm, for any chain length used. As reported by the authors in ref. 6, only chains composed by more than thirty beads can reach a plateau value of their end to end square lengths ( $l^2$ ); below this limit chains are not sufficiently long to reach equilibrium and  $l^2$  oscillates largely; this resulted from our experience too.

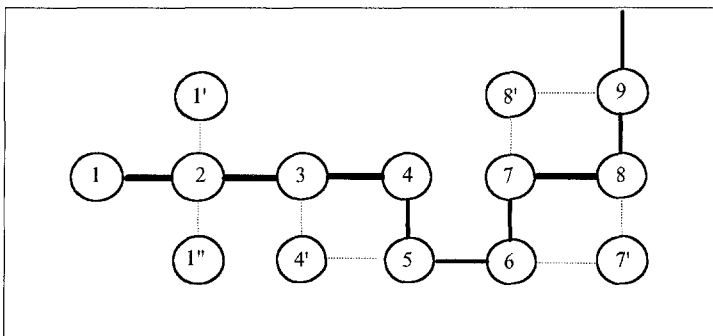

Fig. 1 - Two dimensional projection of the possible motions of the beads constituting the chain model. The initial position of the chain is shown with solid lines, while the dotted ones indicate the possible motions of the beads. You can note that the end bead moves more freely than the others.

The average end to end square lengths were obtained after  $4N^3$  cycles, where  $N$  is the number of beads composing the chain, and will be reported later in tab 1; the conformations used to calculate this average value are those obtained after each  $N^2$  computer cycles; the  $l^2$  value obtained after the first cycle has always been discarded since too near to the stretched, initial conformation. The "relaxed" chains used in our simulations were chosen among the ones showing a  $l^2$  value within a strict interval from the average value calculated. For short chains that show wide oscillations in their  $l^2$  values, the last conformation after  $4N^3$  cycles was arbitrarily taken as the reference starting one. After this first step the computer chose a random disposition in the cubic lattice of the centers of mass of the "standard" molecules obtained as previously described all with the same orientation in space (fig. 2).

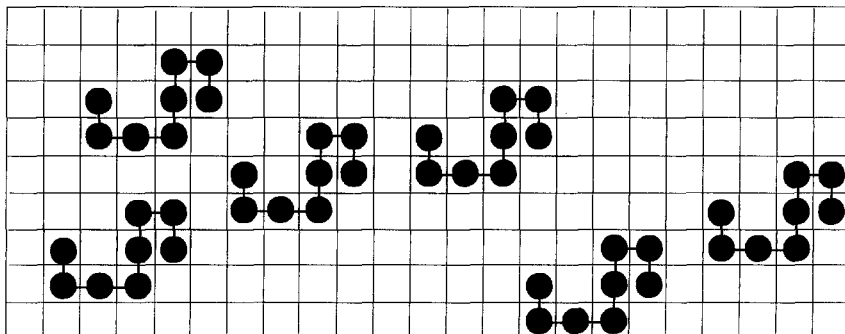

Fig. 2 - Example of starting system configuration used in simulations (two dimensional projection)

The total number of cells in the cubic lattice, necessary to obtain the desired concentration in volume, was determined both by the number and length of the molecules in the system. For example, ten chains ten beads long must be placed in a lattice with one thousand cells to have a 10% solution. To consider the lattice infinite and to maintain the same concentration during the simulation, we assumed that any molecule or molecule segment exceeding the boundaries of the lattice should reenter from the opposite side.

Our algorithm operates selecting randomly one chain at a time and choosing, again at random, one of the beads in the same chain. The status of the bead is checked and if does not results irreversibly bonded or unable to move according to the rules of the Verdier-Stockmayer algorithm, it is shifted to one of the accessible sites. A check is subsequently made to evaluate the presence of a bead of a different chain in the sites laterally adjacent the one just occupied. If such a case is detected, a contact is formed and the two beads are labeled as bonded. At this moment the computer checks the neighboring beads in the two chains involved in the interaction to evaluate if an irreversibly bonded sequence is formed. A sequence of bonded beads is considered irreversible if it is composed by, at least, three successive elements in the same chain. These beads are *frozen* from the moment the sequence is formed, that is to say that from that computer cycle on the beads forming the bond can no longer be moved and change the lattice sites they occupy. It must be noted that when two beads come in contact and one or both of them are adjacent to an irreversible sequence in any of the two chains involved, they become frozen. If the computer detects that no irreversible bond, or no bond at all, is formed, the chosen beads can undergo successive movements and, in case, may be detached in a successive cycle. As obvious, the sequences of irreversible bonds pin the chains in a particular position in the lattice, since the only way for a chain to shift in space, in this model, is by the movement derived by the Monte Carlo method here employed. The presence of beads stuck in fixed positions in the lattice prevents the chains to which they belong from shifting, even though any bead not irreversibly bonded in the same chains is still free to move. We must remark that no particular thermodynamic consideration was taken into account in deciding the length of chain along which bonds had to take place to form stable linkages (three successive beads, in this case). Of course any real chemical system has its own behavior that is due to polymer-polymer and polymer-solvent interactions, and any case will differ from any other. Our choice was only intended to simulate cooperative linkages in principle, without any further consideration, and you could try to test any sequence length you may consider appropriate.

After an average of  $4N^3$  moves per chain has taken place the simulation is stopped and the system analyzed to verify the number, size and kind of aggregates formed. The model was transcribed in a compiled computer program to obtain a fast execution. The use of a 66 MHz 486 CPU based computer allowed the parallel simulation of all the chains in the system within an acceptable time scale and several runs were performed to obtain average, reliable results.

## **Results**

Simulations have been performed varying both chain lengths and volume concentrations for several monodispersed chain populations. In this way we have investigated the dependence of the aggregation phenomenon based on this cooperative mechanism, both on concentration and chain length (or rigidity, as we will see later).

For concentrations in volume below 1% such a model does not allow the formation of stable aggregates for any chain length used. Although several collisions occur during the simulations, their number depending on the chain length and concentration, the formation of irreversible bonds is irrelevant from a statistical standpoint. This fact indicates that our model is somehow demanding when compared to the experimental behavior of several self aggregating polymers which can give gels or precipitates at concentrations that are much lower than 1%. As a consequence no particular remark can be reported for our simulated systems in this concentration range. Our results are more interesting when the concentration of the model chains is raised up to 1% in volume and different behaviors are observed depending on chain length. We can now note that short chains, formed by ten beads give aggregates with a relatively high per cent of superimposed beads and the lengths of these formations is not much higher than that of a single chain; these aggregates are composed, on average, by two or three molecules and a sort of equilibrium situation is attained when about 50 - 60% of the chains are

bonded (fig. 3). Of course longer simulation cycles can lead, in the end, to the bonding of all the molecules present in the system, but not to a significantly different aggregation geometry. Since the lifetime of aggregates strongly depends on the chemical system and is very demanding in terms of computer time, we decided to consider it as infinite, i.e. the bonds as irreversible, and did not exceed the  $4N^2$  average cycles per bead even in this system where further evolution could be expected. Longer chains, composed by twenty beads show a similar behavior, differing only in the slightly higher number of molecules involved in the formation of the aggregates obtained at the end of the simulations. Longer chains composed by thirty or forty beads tend to aggregate in a different fashion involving a higher number of molecules.

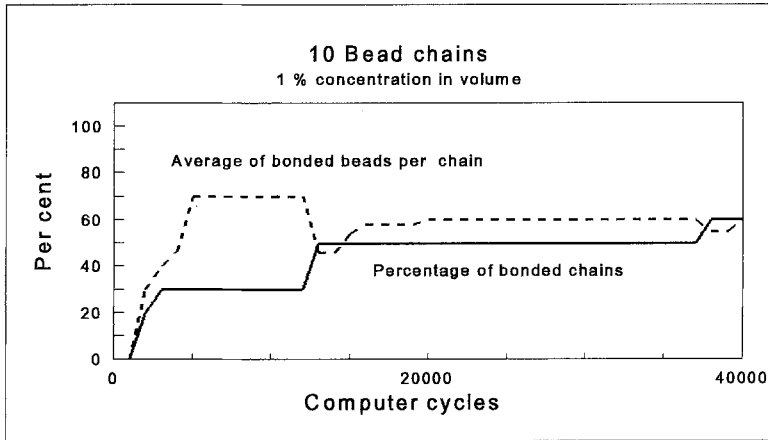

Fig. 3 - Percentage of bonded chains and bonded beads per chain in function of computer cycles (10 bead chains, 1% concentration)

As can be seen in figure 4, up to 90% of the chains composing the systems aggregate, but only a relatively little part of their beads are involved in effective bonds. In this situation the formation of three dimensional networks seems to be preferred to the side by side aggregation typical of shorter chains, and aggregates involve a higher number of molecules where any chain has contacts with many other ones.

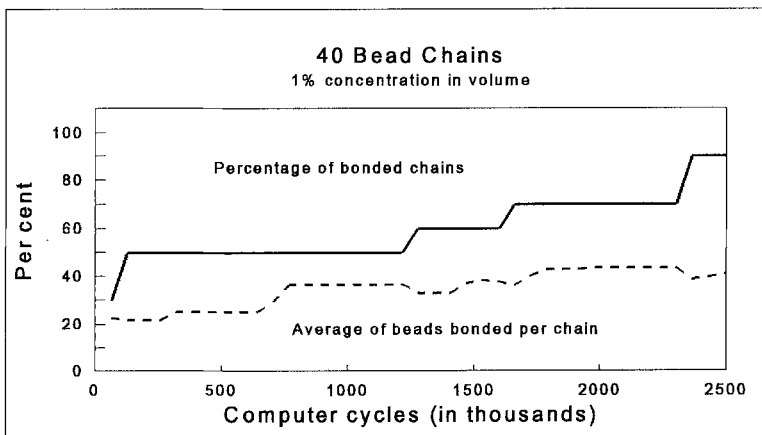

Fig. 4 - Percentage of bonded chains and bonded beads per chain in function of computer cycles (40 bead chains, 1% concentration)

The behaviors reported above are confirmed and more evident at higher concentration. When it is raised up to 2% in volume, we can see that the percentage of ten bead chains bonded is near to 80% and the number of beads involved in the interactions is higher (fig. 5). The aggregates are again composed by two or three chains, on average, preferentially bonded side by side, and this tendency seems

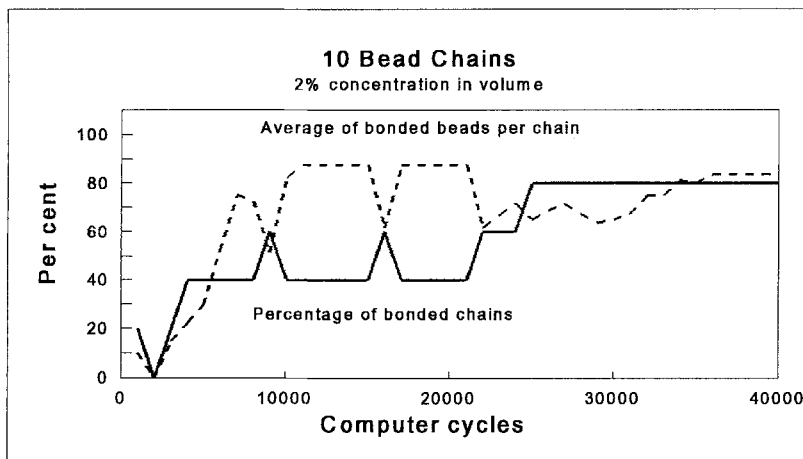

Fig. 5 - Percentage of bonded chains and bead in function of computer cycles (10 bead chains, 2% concentration)

to be enhanced by concentration. Twenty bead chains, again and more evidently, form somewhat larger aggregates, composed by a higher number of molecules and with a more complex geometry (fig. 6). On the other hand longer chains have no more than about half of the beads composing the chains involved in interchain interactions and we can note that in these cases aggregates are made by many more molecules than observed for shorter chains; in particular, chains made up of forty beads, at this concentration, can form one single aggregate composed by all the molecules in the system, comparable to an infinite gel (fig.7).

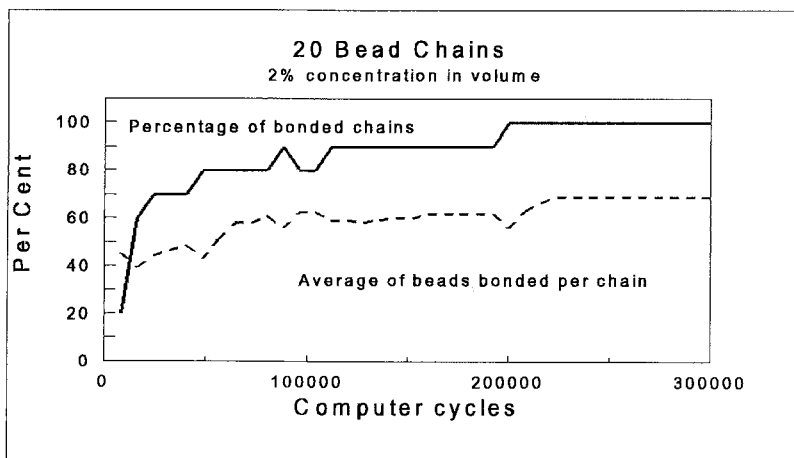

Fig. 6 - Percentage of bonded chains and bead in function of computer cycles (20 bead chains, 2% concentration)

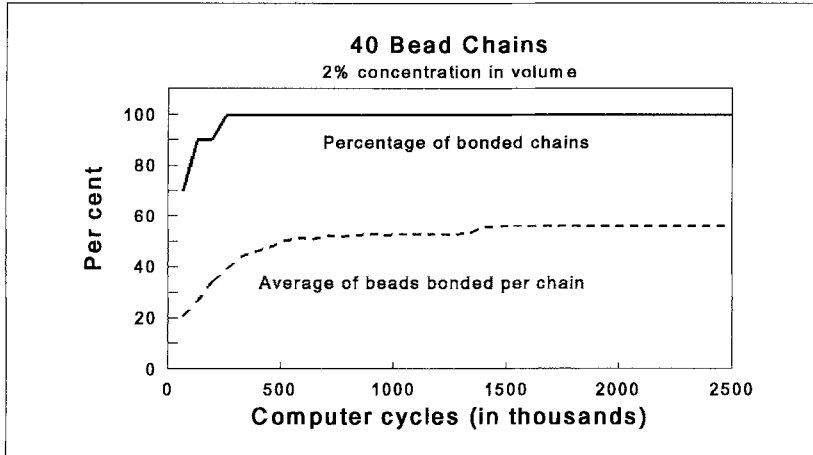

Fig. 7 Percentage of bonded chains and bead in function of computer cycles (40 bead chains, 2% concentration)

### Discussion

We can compare the results of our simulations to the phase diagram of a generic polysaccharide (fig. 8). This parallel is not intended to interpret a specific diagram, but only as a reference to extrapolate the indications emerged from our simulations. We can see that low molecular weight fractions of amylose give precipitates, while high molecular weights give gels. Between these two extremes we notice the presence of intermediate states, depending on concentration too, where both states coexist.

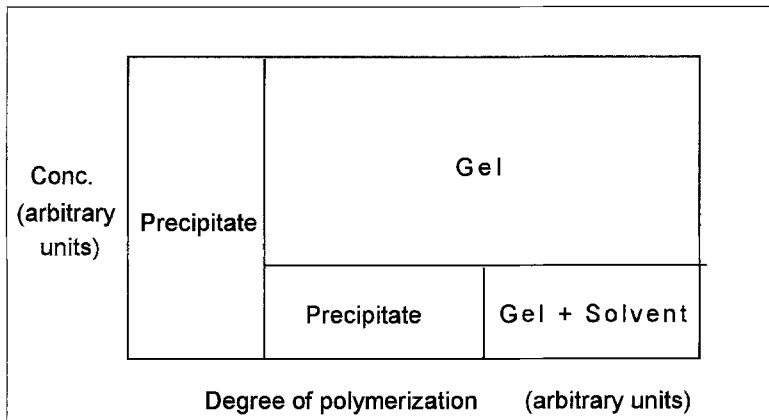

Fig. 8 - Schematic phase diagram of a generic polysaccharide

In our model, short chains, thanks to the linking mechanism here simulated, seem to prefer to overlap a large part of their lengths, giving aggregates involving only a few chains. A more sophisticated model, allowing the shifting motion of aggregates along the lattice should, probably, confirm the lateral growing of these "crystalline" seeds, leading to compact structures and precipitation. On the other side, a polymer chain of higher molecular weight, thanks to the same aggregating mechanism, can

be involved in interactions with several other ones, because only a short part of its beads is necessary to assure a stable linkage; as a consequence we observe the preferential formation of a three dimensional network structure. Since the formation of a gel-like structure, where molecules have a low mobility and the network they form can be obtained thanks to the movements of long segments not yet involved in bonds, the model we employ can rather accurately represent such a situation, whereas for shorter chains we just have a hint of the possible mechanism by which lateral order arises. Also the different behavior of intermediate states, with particular reference to differences arising from molecular weight, is possibly just hinted at by our model, and the presence of aggregates composed by few molecules with others of larger dimensions in chains formed by twenty beads could be seen as a representation of the coexistence of gel and precipitate but, as a matter of fact, such an interpretation seems a bit too adventurous in the context of this model.

As we said before, this model can be used to try to evaluate the phase behavior of rather rigid self aggregating molecules too. This can be obtained rescaling the proportions of the lattice cells in comparison with experimental systems. We have tentatively tried to correlate the static properties of our model chains with experimental values reported in literature (8) and new data obtained in our laboratories about chitin samples. We have so obtained a relation between experimental data referred to fully characterized samples and our model chains of different lengths (tab. 1). The experimental data reported in this table have been obtained by light scattering measures and give the persistence length values and gyration radii of four chitin samples; from the Kratky-Porod relation for worm-like chains (9), knowing the contour lengths of the chains, we have then calculated the end to end average square lengths of the four samples.

*Table 1 - Molecular weights of experimental samples, lengths of model chains, and square end to end average lengths.*

Chitin $M_w$	$\langle l^2 \rangle 10^{-3}$ (in $\text{\AA}^2$ )	N° of Beads	$\langle J^2 \rangle^*$
100000	933	10	20
190000	1844	20	108
302000	2980	30	152
400000	3970	40	244

\* Values normalized to the dimensions of one bead

The  $\langle l^2 \rangle$  values, normalized to the end to end average square length of the longest chain ( $M_w = 400000$ ,  $L = 40$  beads) have been plotted vs. the molecular weight of the chitin samples (8). On the same plot we have reported the end to end average square lengths of the model chains used in our simulations whose values have been obtained as previously described (fig. 9). As we can see we observe a good agreement between experimental data and the values obtained in our model. Our simulation seems to be sufficiently accurate in reproducing the static properties of chitin molecules and we have tried to interpret the phase behavior of this experimental system on the base of the results we have already discussed. In particular, the tendency of short molecules to give lateral aggregation phenomena, could be responsible for the decreasing of the axial ratio below the threshold of mesogenicity because of the increased diameter of these rod-like aggregates. In this way chitin, in spite of its structural rigidity, could not show liquid crystalline phases in solution; the fact that other polysaccharides, such as cellulose, instead show such mesogenic properties could be ascribed to the different strength of the intermolecular forces involved in aggregation in different chemical systems. High molecular weight chitin samples, because of their tendency to give gels even at very low concentrations, cannot give such a phase too (5).

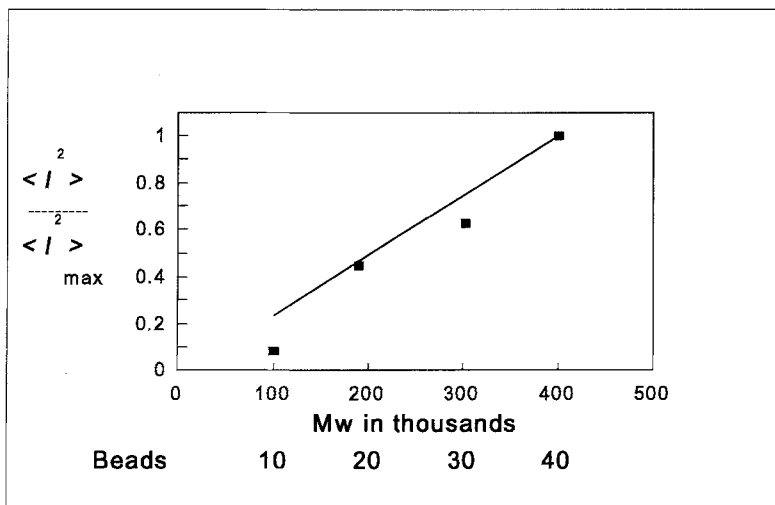

Fig. 9 - Experimental  $\langle l^2 \rangle$  values for chitin samples (line) vs.  $\langle l^2 \rangle$  values of model chains (black squares)

### Final remarks

The model here employed has obvious limits and approximations; among these the fact that aggregated molecules can no longer shift along the lattice and, mainly, the rough rendering of intermolecular forces so that its validity is only qualitative. Nevertheless it can be observed that even a simple simulation, based on the hypothesis of a bonding mechanism requiring the co-operation of weak forces along relatively long sequences of polymer chains, remarks great differences in the behavior of chains of different length. As evidenced, we have a confirm that molecules whose length largely exceeds the segment over which stable interactions form, tend to give rise to networks rather than crystalline or compact precipitates. Our results, obviously strongly influenced by the chosen algorithm and parameters, shows that if the ratio between the minimum length over which stable interactions form and the contour length of the molecule is below about 0.15, the kind of aggregation preferred is a compact side by side; above this threshold chains give networks. A possible explanation of the apparent inconsistency between rigidity evaluations of chitin chains with their non-mesogenic nature has also been attempted by this model and could be a sound hypothesis to explain the phase behavior of low molecular weight samples of this polymer.

### References

- 1) M. J. Gidley and P. V. Bulpin, *Macromolecules*, **22**, 341 (1989)
- 2) D. A. Rees, E. R. Morris, D. Thom, J. K. Madden in "The Polysaccharides", Academic: New York, 1982, Vol. 1 pp. 195 - 290
- 3) P. J. Flory, *Macromolecules*, **11**, 1141 (1978)
- 4) M. Terbojevich, A. Cosani, G. Conio, A. Ciferri and E. Bianchi, *Macromolecules*, **18**, 640 (1985)
- 5) M. Baldini, Master thesis in Chemistry, University of Genova, (1993)
- 6) A. C. Balazs, C. Anderson and M. Muthukumar, *Macromolecules*, **20**, 1999 (1987)
- 7) P. H. Verdier and W. H. Stockmayer, *J. Chem. Phys.* **36**, 227 (1962)
- 8) M. Terbojevich, C. Carraro, A. Cosani and E. Marsano, *Carbohydr. Research*, **180**, 73 (1988)
- 9) O. Kratky and G. Porod, *Rec. Trav. Chim.*, **68**, 1106 (1949)